



KELSEY, KEPLER & JULES VERNE 2022



BIRTH OF A LEGEND

The Combi Volkswagen: the culmination of every desire and the on-road symbol of our history. This was the first vehicle ever fitted out by Westfalia in 1951. Remember the sofa bed, fold-down table, bench seat and criss-cross patterned fabric... What a great mobile hotel thanks to its comprehensive, quality fittings! The Combi was an instant hit and even spread beyond continental Europe to penetrate the American market.

These models of yesteryear based on on T1, T2, T3 or T4 chassis are now amongst the most sought after used vehicles in the world, with their value exceeding their original retail price!

And today the saga continues with the improved onboard living still based on the cornerstones of freedom and independence.

*More than 65 years of
Westfalia quality*





1844

'Camping Box':

The first fittings kit. At the request of a British officer who had a VW van and wanted to fit it with a sleeping, living and working space, Westfalia started manufacturing Camping Boxes. Through this kit, the first Westfalia recreational vehicle was born.



1962

Launch of the Jules Verne and Kepler models.

Westfalia continued to grow, launching the first minivans with kitchen, living room, bathroom and toilet! They were an instant hit and led to the rapid development of new layouts in that range.



2019

◀ The Westfalia adventure begins..

On 1 October, Johann Bernhard Knöbel opened a forge and laid the groundwork for an enduring adventure. He initially built horse-drawn carriages to transport goods from the train station.



1951

◀ Westfalia SO 34.

In 1962, Westfalia launched the SO 34 on a VW Camper base with a key innovation: the ability to rotate the back of the bench seat 180°. This was also the first campervan made from white and grey thermoformed parts instead of wooden surfaces. The model was a resounding success, particularly in the USA, due to its good insulation.



2016

◀ 175 years of Westfalia.

Over the years, the brand has revolutionised the camping world. Its distribution network and range of products have continued to expand. The Westfalia range currently features more than 20 different models and has around one hundred dealers in Europe.

KEPLER FIVE

Availability left handdriving only

Hitting the road in a campervan is an adventure that can be enjoyed as a couple, family or group of friends. And age is no barrier! Whether you are 20, 45 or even 70 years old, there are no limits for enjoying adventure and freedom.

The Kepler Five is equally designed for travelling as a pair or even a large family, taking you exactly where you want so you can enjoy adventure and freedom.

Use it as an MPV during the week and an RV on the weekend for your spontaneous getaways! The Kepler Five is ideal for urban driving as its 4.9 meters (16 ft) length makes it the most compact model in the range.

Perfect for your family holidays



Double bed The double bed under the Kepler Five's pop-up roof is comfortable and spacious. It measures 1.90 x 1.20 m and is easy to access.



Kitchen Featuring a stainless steel sink, large fridge and a two-burner stove, the kitchenette is laid out so that you can access it from inside and outside!

Bench seat It only takes a few steps to transform the 3-person bench seat into a bed measuring 1.87 x 1.10 m!



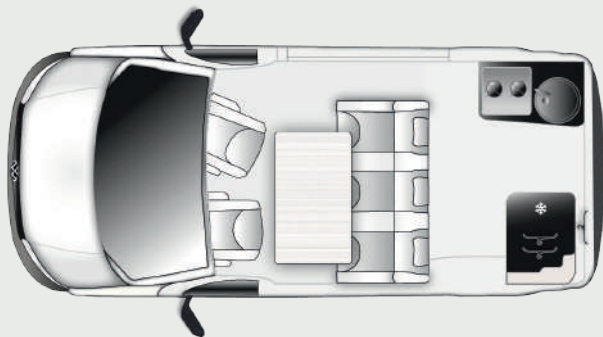

Day layout

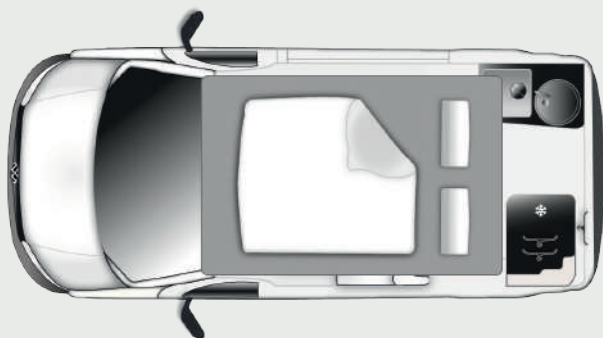

Night layout

Features of Kepler Five

- + Ultra-compact campervan (4.90 m short version)
- + Transports up to 5 people
- + Everything you need for travel (fresh water tank: 64 litres, kitchenette, outdoor shower, etc.)
- + Ease of movement within the vehicle at all times



1 You can choose the option of a toilet area or additional storage chest.



2 Optimal storage capacity with a large, deep cupboard where you can easily store your clothes and other belongings.



BE A HEDONIST!

Devote time to what you love, organise trips to the beach, spend evenings gazing at the full moon and the stars, watch your favourite film; in short, enjoy the simple pleasures of life. This is precisely our campervan concept.

With the Kepler Five, you can enjoy independence and travel at your own pace while carrying what you need with you.

After a day of exciting adventures, you will enjoy returning for a good night's sleep. The upper bed features full support thanks to the FROLI base, a product used in leading hotels and wellbeing establishments. Insulation and heating are also standard features, with Webasto diesel heating so you can enjoy your campervan all year round. And the LED lights, with the Westfalia signature lighting, create a wonderful atmosphere.



Another feature : the Kepler Five is the only campervan on a VW short wheelbase to have a „home-style“ refrigerator.

KEPLER SIX

Availability left hand driving only

No other model in the range illustrates the concept of freedom as well as this campervan. Whether you are travelling with 2, 3, 4, 5 or even 6 people, your campervan can adapt to your lifestyle. It is great for everyday use to transport things during the week and for leisure use on the weekends. Step aboard as a couple, family or group of friends. Your campervan is always ready to hit the road. Head out to enjoy a lakeside picnic, a day at the beach or even a surfing session!

Perfect for adventures



Multipurpose layout

Individual, removable seats

Compact 5.30-metre length



RE-EXPERIENCE FLEXIBILITY!

Freedom and independence is what we all seek. The freedom to choose where our travels will take us. The freedom to stop or continue driving, as we feel. After all, that is the appeal of travelling. With the Westfalia Kepler Six, you get a campervan that perfectly caters to this need. The campervan sits on a T6 VW with a long wheelbase. It drives like a sedan thanks to the powerful turbo diesel engine combined with quality suspension, so you can travel in comfort.

On this base vehicle, the Kepler Six features a pop-up roof, kitchen, sleeping area and storage space, making it not only a multipurpose recreational MPV but also a valuable everyday vehicle that will quickly become an essential part of your life.



The Porta Potti option is now available and allows you to have a discreet removable toilet area. This option includes the Porta Potti and the trunk with bench seat.



Flexibility and modularity

Individual seats allow for a flexible and modular layout.



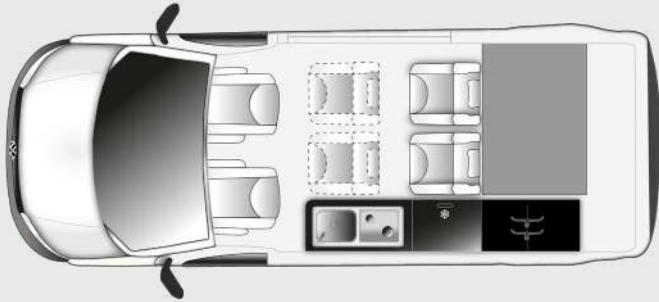

Day layout

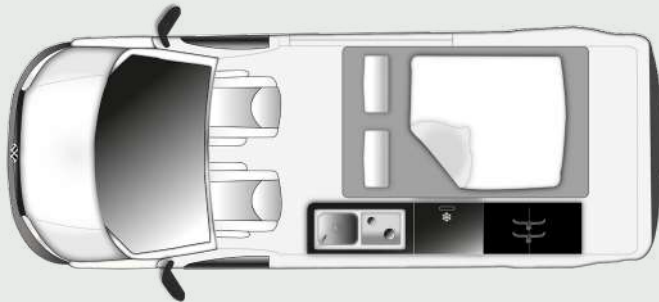

Night layout

Features of Kepler Six

- + Flexibility and versatility
- + Transports up to 6 people
- + Multipurpose layout
- + Comprehensive fittings



Practical!

The kitchen block, with its well thoughtout functionality, does not fail to impress. Storage space solutions are also integrated to perfectly suit a 2-flame cooker and a refrigerator.

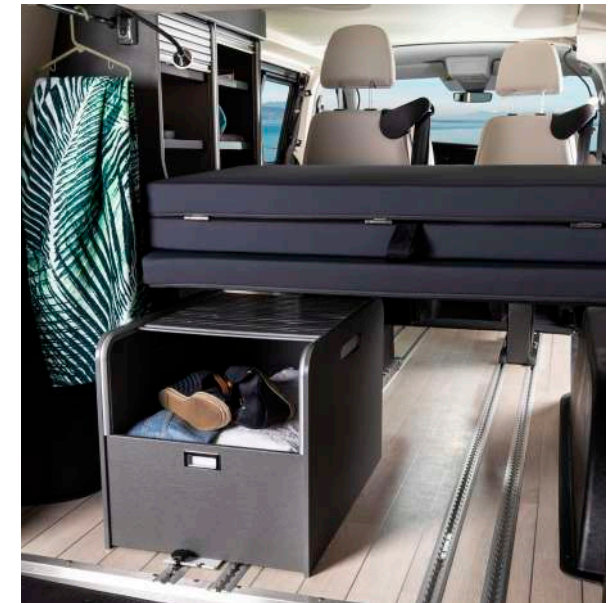

Many storage spaces

The implementations of our models have been designed to offer you the maximum storage space.



Configuration without seat with closed bottom bed.



INNOVATIVE AND ACTIVE!

The Kepler Six is a highly versatile vehicle. Whether you take the road to four, five or six people, the Kepler Six multiplies the arrangements and configurations to accompany you in all your daily and leisure activities. Whether it is for a weekend use to attend a sporting event or a festival, your vehicle will be ready to leave for all your adventures!

Comfort is also one of the key concepts of this model. The kitchen block allows you, for example, to prepare a delicious menu in no time at all. The developed bottom bed system by Westfalia also offers a high level of comfort thanks to its structure and the choice of materials.



In a few simple steps, you can install your bed in the living room of the Kepler Six. Once folded, the bed can also be advanced or backward thanks to several notches. A highly appreciated flexibility!

KEPLER ONE

Availability left handdriving only

In the morning, as your day starts, the first rays of sunlight shine through your Kepler One's window. You make your coffee in the kitchen before sitting outside to enjoy your breakfast with delicious fresh bread.

You will enjoy experiencing this everyday scene!

With the Kepler One, it is simple to start your day on the right foot, thanks to the bathroom with shower and toilet. Maximum comfort for amazing holidays!

Perfect for your family
holidays



Double bed The double bed under the hinged roof of the Kepler One is comfortable and spacious. It offers a surface area of 1.90 x 1.20 m. The lounge area can be also converted in a few steps into a double bed.

1

2

Kitchen The Kepler One also has a separate kitchen. In addition to a two-burner stove, sink and laminate worktop, you will find many drawers there for your kitchen accessories.



Lounge The living room of the Kepler One has a spacious lounge area. You can also rotate the driver and passenger seats and integrate them into the lounge area quickly and simply.

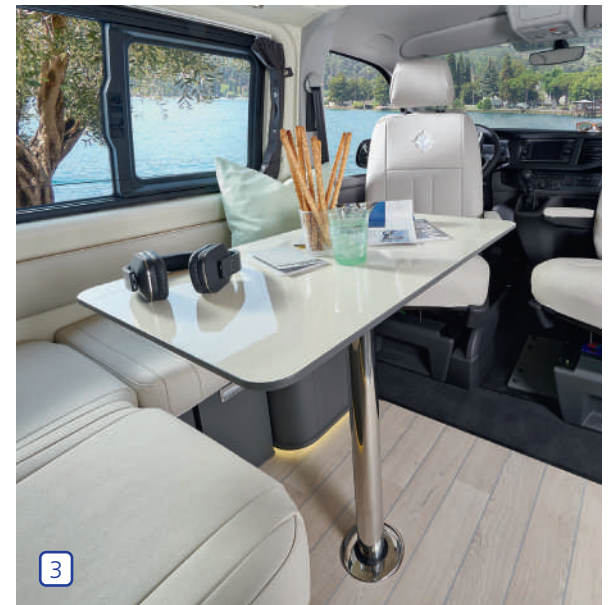



Comfort Thanks to its long wheelbase (17.5 ft), the Kepler One has a very large lounge area, which can also be transformed into a bed.





WELCOME TO THE FAMILY!

Westfalia - this name stands for motor homes like no other. They combine innovation and function, perfect workmanship and uncompromising everyday suitability. This holds true today, just like it did more than 65 years ago when the first Westfalia car was manufactured and the Jules Verne and Kepler models are a testament to this fact. The motor homes enthrall you at first glance as you enter the living area. They come in bright, homely colours that give them a classy look and they have a lively atmosphere thanks to their powerful contrast. They set a benchmark in this class.

We purposely chose a long wheelbase for Kepler One, which is developed on the chassis of the Generation 6.1 Volkswagen Transporter. The space gain as compared to short wheelbase alone allows for a large seating area in the living room, thus giving it a lounge feel. Large windows and a sophisticated lighting system give a friendly, bright and homely feel. But there is nothing like seeing it for yourself. So give it a shot!



1 Discreet and practical. Once removed, the dining table can be easily stored in the side door.



2 Did you know that? Our shower trays are made of polyester (not plastic) and they are „handmade“ in our workshops.

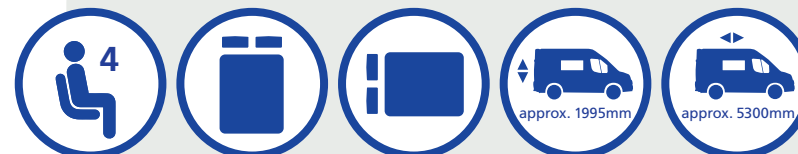

KELSEY

Love at first sight comes completely unexpected. You will surely feel this feeling here, in the new Kelsey, which takes over the popular and beloved lay-out of the Kepler One.

In a few words : a large L-shaped living room, a fully equipped kitchen with sink and gas plates, a fixed shower and WC. All with contemporary furniture, warm colours and a multitude of equipment that make it one of the most comfortable and pleasant models.

Perfect for the holidays
and daily life



Double sliding door

Full equipped kitchen

Compact 5,34 m length





The double sliding door as standard is also very practical in the daily life and bring even more luminosity.



FULL-EQUIPMENT

As a car-style RV, the Kelsey stands out with its Ford chassis and boasts a very full equipment as standard, as well as for the cab and the cell. As example, you will particularly appreciate the LED running lights and fog lights as standard.

On the cell side, the vehicle has the particularity to possess high equipment such as a compressor frige like at home, or even a diesel heating and hot water boiler as standard.

Its modern design and brightness give it a snug style, delivering an unrivalled feeling of wellbeing. With its 4 seats capacity, you should already be imaging yourself on board !

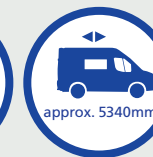
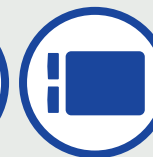

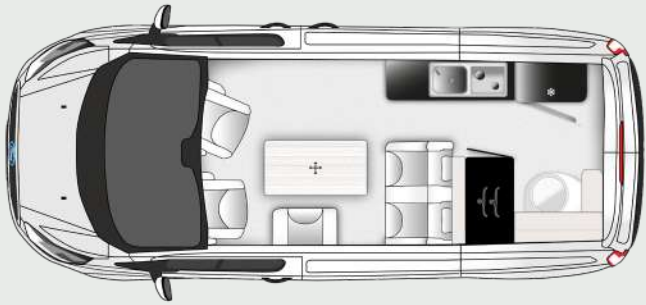

Day layout

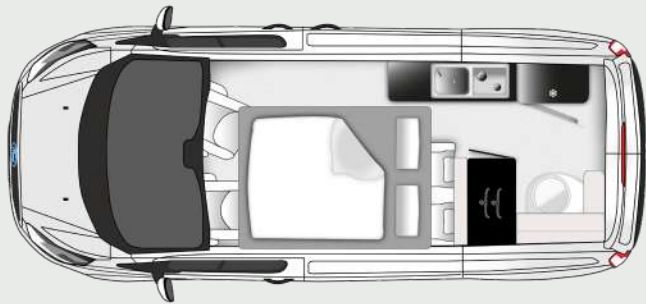

Night layout

Features of Kelsey

- + Compact length of 5.34 metres
- + Comfortable, large seating area
- + Private bathroom with shower and toilet
- + Double sliding door



Its unique layout provides space to walk within the vehicle from the top to the back. Moreover, big storage volume allows us feeling comfortable when cooking.



The shower and fixed toilets provide also an indisputable comfort.



A DREAM

What a joy to lie in a comfortable bed after a day full of adventures and emotions! For a good night's sleep, we bring you the maximum of comfort with our FROLI system ceiling beds. This system provides an excellent quality of sleep thanks to its support step by step. Designed to last, this innovation also provides excellent air circulation.

In terms of dimensions, the Kelsey's double bed has a surface area of 190 x 120 cm on the mezzanine floor.

For the lower bed, the bench in the living room can be transformed in an extra bed, which allows you to have 4 sleeping places.

You will be well rested to continue your journey!



The « swan neck » lights allow you a reading time before sleeping !

JULES VERNE

You are sure to have already noticed that the Jules Verne is a unique model, standing out with its exclusive car-style design. No doubt about it, whether in the Elegance or Avantgarde version this Jules Verne is definitely eye-catching.

Inside, it features the best living space. The living room is designed around the L-shaped bench seat, a rare feature in the pop-up roof campervan category. The luxury kitchenette provides maximum comfort with a 2-hob stove, sink and large 51-litre refrigerator.

Perfect for your next city tour with its compact length (5.14m)



Private bathroom

Comfortable living room space

Compact 5.14-metre length



The interior is presented in Elegance version with chrome pack.



IT IS ALL ABOUT THE SPACE!

A spatial impression, developed around the Mercedes Vito, is also achieved with Jules Verne.

Of course, what applies to the Kepler One is also provided on the Jules Verne - a similar van concept on an even more premium bodywork. Thus, for the Jules Verne, the Mercedes Vito serves as a platform for the installation of a bicycle- innovative vehicle. There are many attributes of this vehicle, including its compact and agile ability to navigate underground car parks. For the Jules Verne, the interior design also includes a large warm side dinette that can be converted in a few manipulations into a double bed. A second double bed of dimensions 190 x 117 cm is located in the folding roof.

Equipped with a driving position like a saloon car, the driver and passenger seats swivel easily and thus allow integration into the living room in no time at all.

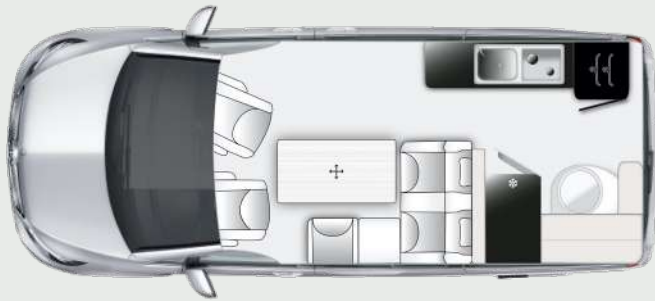

Day layout

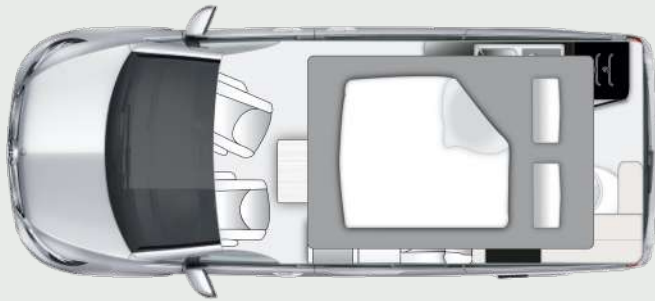

Night layout

Features of Jules Verne

- + Compact: 5.14-metres long and fits under the car park height bar (under 2 metres)
- + Comfortable living room space with chaise longue
- + Private bathroom with shower and toilet
- + Ease of movement within the vehicle at all times



Sleeping capacity for up to 4 people

The lounge area can also be transformed into an additional sleeping area thanks to the two mattresses stored in the wardrobe behind the bench, providing a smart use of space.



Comfort & Technology

This model features 6 USB ports as well as a 12 V and a 230 V outlet.

Meridian Salon The best comfort to lengthen your legs and relax. The removable table further accentuates this feeling of space and well-being.



Avantgarde version shown here.

VOLKSWAGEN CHASSIS

As you know, the Westfalia story started in 1844 and our brand has become famous worldwide thanks to our first campervan using the... Volkswagen Camper!

Today, we continue this collaboration with our Kepler models.

With the T6.1 Transporter base, the successor to the Campers, Volkswagen maintains its reputation for excellent driving comfort. Its DSG also has a reputation as one of the best on the market, with ultra-fast gear shifts.



| Version | Engine | Transmission |
|------------------|---|-------------------|
| Kepler - VW T6.1 | 90 hp, 66 kw, 220 nm | Front-wheel drive |
| Kepler - VW T6.1 | 150 hp, 110 kw, 340 nm (Automatic gearbox) | Front-wheel drive |
| Kepler - VW T6.1 | 204 hp, 198 kw, 450 nm (Automatic gearbox) | Front-wheel drive |

Indicative Volkswagen figures. Subject to modifications and improvements.



MERCEDES CHASSIS



Mercedes is undoubtedly a key automotive world brand, with a reputation for reliability, elegance and technical expertise.

Our partnership with Mercedes goes back to the 1980s and intensified with the creation of our Jules Verne model. Sitting on a Mercedes Vito base (the leading vehicle in the light utility category), our Jules Verne model boasts the best living space and is both a stylish vehicle and an RV.



1 The Avantgarde version of the Jules Verne boasts 17" Premium diamante rims.



2 Available as an option, the all-wheel drive transmission delivers impressive engine and terrain-crossing abilities.

| Version | Engine | Transmission |
|-------------------------------|--|------------------|
| Jules Verne - MB Vito Euro 6d | 136 hp, 100 kw, 330 nm Automatic gearbox standard | Rear-wheel drive |
| Jules Verne - MB Vito Euro 6d | 163 hp, 120 kw, 380 nm Automatic gearbox standard | Rear-wheel drive |
| Jules Verne - MB Vito Euro 6d | 190 hp, 140 kw, 440 nm Automatic gearbox standard | Rear-wheel drive |

Indicative Mercedes figures. Subject to modifications and improvements.

FORD CHASSIS

Becoming very popular, the Ford chassis is renowned for its comfort and full equipment as standard.

Also available with many options such as the xenon front lights or reverse camera, the Kelsey will allow you to enjoy great adventures in complete serenity.

| Version | Engine | Transmission |
|---------------------|---------------------------------------|----------------------|
| Ford Transit Custom | 2.0 EcoBlue, 130hp, 96 kw, 360 nm | Front-wheel drive |
| Ford Transit Custom | 2.0 EcoBlue, 170hp, 125 kw, 390 nm | Front-wheel drive |

Indicative Ford figures. Subject to modifications and improvements.



COLOURS

Interior upholstery



Material "Arizona"



Montana two-tone fabric
(optional)

Kepler car body colours* (Volkswagen)

Solid paint



Candy-white

Metallic paint** (optional)



Beige Mojave



Indium-grey

Bi-colour paint***



Two-tone Grey and
Fortana Red

Bi-colour paint***



Two-tone Candy White
and Bay Green

Jules Verne body colours* (Mercedes)

Solid paint

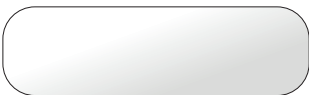

Arctic-white

Metallic paint** (optional)



Silver-grey Adamentin



Blue Cavansite



Sélénite Grey
(Available only on the Avantgarde Version)

Kelsey body colours* (Ford)

Solid paint

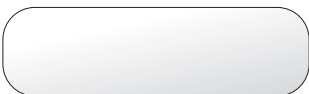

Ice White

(optional)



Moondust Grey

(optional)



Azure blue

- * Please check for colour availability when ordering the vehicle.
- ** Metallic paints are extras as of time of printing. The shades illustrated here can vary from the original shade due to printing technology.
- *** Variable availability.

KEPLER FIVE

| | |
|---|--|
| Base | Volkswagen Transporter T6.1 |
| Diesel engine | 2.0-litre TDI 66 kW/90 hp |
| Gearbox | 5-speed manual gearbox 7-speed DSG option (150 hp engine) |
| Transmission | Front-wheel drive |
| Length / width / height | 4900 mm x 2297 mm (wing mirrors extended) x 1995 mm |
| Mass in running order (VO (EU) 1230/2012)* | 2465 kg (estimation for 90 hp manual gearbox) |
| Gross vehicle weight | 3000 kg |
| Payload** | 235 kg (estimation for 90 hp manual gearbox with 5 people) |
| Berths/Registered (driving) seats | 4 / 5 |
| Freshwater and waste water tank | 64 l / 36 l |

This data is indicative, non-contractual, and may vary according to the versions.

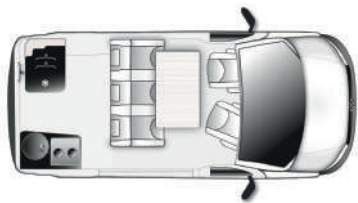

Day

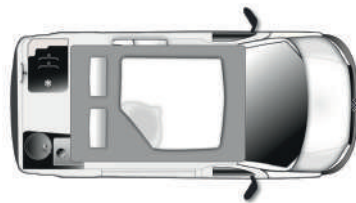

Night

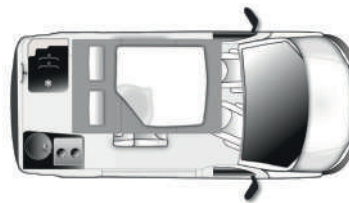

Night

Dimensions

Measurements:

Kepler Five

| | |
|---------------------|----------|
| A: Wheelbase | 3,000 mm |
| B: Length | 4,904 mm |
| C: Width | 2,297 mm |
| D: Height | 1,995 mm |

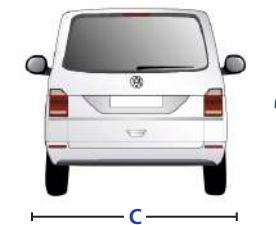
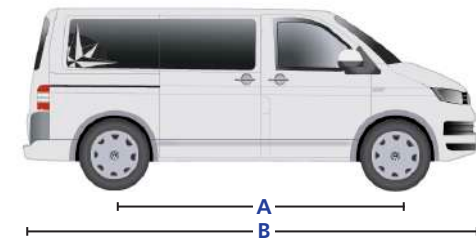

* Mass in running order including driver (75 kg), Fuel tankful (90%), Freshwater tankful (100 %), Gas supply with cylinder as well as tool kit, adapter cable and extension cable.

** Payload: Difference between „gross vehicle weight“ and „mass in running order“.

KEPLER SIX & KEPLER ONE

| | Kepler Six | Kepler One |
|---|--|---|
| Base | Volkswagen Transporter T6.1 | Volkswagen Transporter T6.1 |
| Diesel engine | 2.0-litre TDI 66 kW/90 hp | 2.0-litre TDI 66 kW/90 hp |
| Gearbox | 5-speed manual gearbox | 5-speed manual gearbox |
| | DSG 7-speed option (available from 150 hp) | DSG 7-speed option (available from 150 hp) |
| Transmission | Front wheel drive | Front wheel drive |
| Length / width / height | 5300 mm x 2297 mm (incl. exterior mirror) x 1995 mm | 5300 mm x 2297 mm (incl. exterior mirror) x 1995 mm |
| Mass in running order (VO (EU) 1230/2012)* | 2509 kg (estimation for 90 hp manual gearbox) | 2543 kg (estimation for 90 hp manual gearbox) |
| Gross vehicle weight | 3000 kg (3,2T as option to obtain 6 registred seats in 4 Motion) | 3000 kg |
| Payload** | 113 kg (estimation for 90 hp manual gearbox with 6 people) | 233 kg (estimation for 90 hp manual gearbox with 4 people) |
| Berths/Registered (driving) seats | 4 / 6** | 4 / 4 |
| Freshwater and waste water tank | 40 l / 30 l | 50 l / 36 l |

Dimensions

Measurements:

Kepler Six & Kepler One

| | |
|---------------------|----------|
| A: Wheelbase | 3,400 mm |
| B: Length | 5,300 mm |
| C: Width | 2,297 mm |
| D: Height | 1,995 mm |

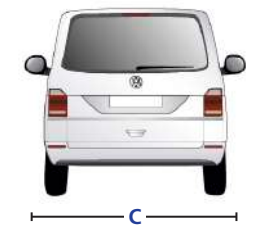
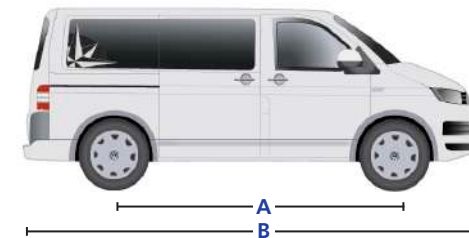

This data is indicative, non-contractual, and may vary according to the versions.

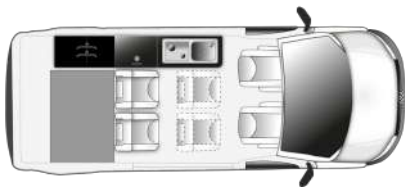

Kepler Six - Day

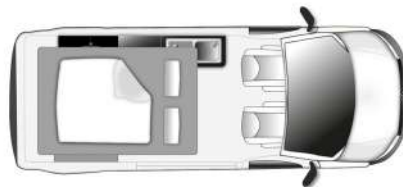

Kepler Six - Night (Top bed)

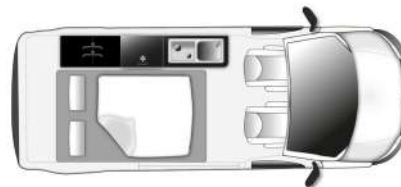

Kepler Six - Night (Bottom bed)

* Mass in running order including driver (75 kg), Fuel tankful (90%), Freshwater tankful (100 %), Gas supply with cylinder as well as tool kit, adapter cable and extension cable.

** 4 seats supplied as standard. The 5th or 6th seats are additional options.

*** Payload: Difference between „gross vehicle weight“ and „mass in running order“.

KELSEY

| | |
|---|---|
| Base | Ford Transit Custom |
| Diesel engine | 130 hp Diesel engine (170 hp optional) |
| Gearbox | 6-speed manual gearbox |
| | Automotive 6-speed gearbox with 215/65 R16 tyres optional |
| Transmission | Front-Wheel Drive |
| Length / width / height | 5340 mm x 2080 mm (incl. exterior mirror) x 2002 mm |
| Mass in running order (VO (EU) 1230/2012)* | 2631 kg (estimation for 90 hp manual gearbox) |
| Gross vehicle weight | 3000 kg |
| Payload** | 144 kg (for 90 hp manual gearbox with 4 people) |
| Berths/Registered (driving) seats | 4 / 5 |
| Freshwater and waste water tank | 50 l / 57 l |

This data is indicative, non-contractual, and may vary according to the versions.



Day

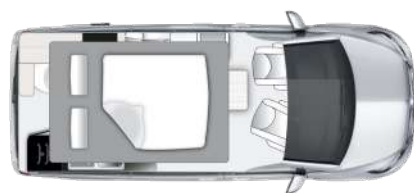

Night

* Mass in running order including driver (75 kg), Fuel tankful (90%), Freshwater tankful (100 %), Gas supply with cylinder as well as tool kit, adapter cable and extension cable.

** Payload: Difference between „gross vehicle weight“ and „mass in running order“.

*** 2,020 mm with alloy wheels 16“.

Dimensions

Measurements:

Kelsey

| | |
|---------------------|--------------|
| A: Wheelbase | 3,300 mm |
| B: Length | 5,340 mm |
| C: Width | 2,290 mm |
| D: Height | 2,000 mm *** |

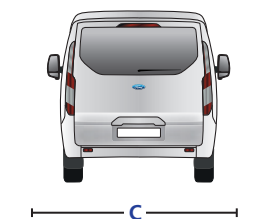
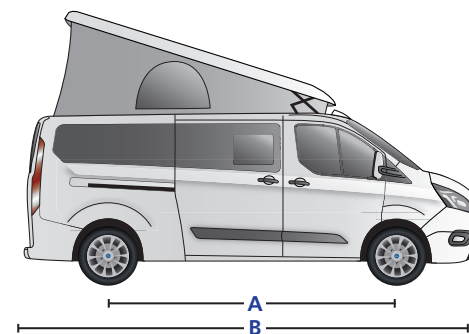

JULES VERNE

Dimensions

Measurements:

Jules Verne

| | |
|---------------------|----------|
| A: Wheelbase | 3,200 mm |
| B: Length | 5,140 mm |
| C: Width | 2,244 mm |
| D: Height | 1,995 mm |



| | |
|---|---|
| Base | Chassis Mercedes Vito 110 CDI |
| Diesel engine | 100 kW / 136 hp |
| Gearbox | 9-G TRONIC |
| Transmission | Rear-wheel drive |
| Length / width / height | 5140 mm x 2244 mm (incl. exterior mirror) x 1995 mm |
| Mass in running order (VO (EU) 1230/2012)* | 2492 kg (estimation for 114 CDI automatic gearbox) |
| Gross vehicle weight | 3050 kg |
| Payload** | 333 kg (estimation for 114 CDI automatic gearbox with 4 people) |
| Berths/Registered (driving) seats | 4 / 4 |
| Freshwater and waste water tank | 50 l / 36 l |

This data is indicative, non-contractual, and may vary according to the versions.



Day

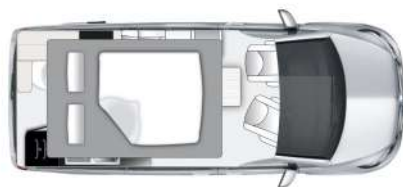

Night (Top bed)



Night (Bottom bed)

* Mass in running order including driver (75 kg), Fuel tankful (90%), Freshwater tankful (100 %), Gas supply with cylinder as well as tool kit, adapter cable and extension cable.

** Payload: Difference between „gross vehicle weight“ and „mass in running order“.

All prices inclusive of the statutory VAT as on July 2021. Subject to modifications. Prices excluding handover inspection and transportation costs.

The General Terms and Conditions of Fleurette Constructeur shall apply. No liability is accepted for printing errors and mistakes. Subject to technical changes. Vehicles are partly shown with optional extras, which do not correspond to the standard equipment (refer to article 2, clause 2 VO (EU) 1230/2012).

A purchase contract can only be concluded with your binding order and the order confirmation of your dealer. The water supply system at least corresponds to standards practices 07/2011 (Directive 2002/72/ EC).

Subject to changes in price, technical details, facilities and equipment, as well as design concept. The information about the scope of delivery, appearance and performance corresponds to the knowledge available at the time of printing. Deviations of +/- 5% are possible for dimensional and weight data, even in running order, and the technically permissible total mass.

As per art. 2, clause 4 a) VO (EU) 1230/2012, the mass in running order is, unless otherwise specified in the catalogue, in the price lists or in the technical specifications, or unless otherwise agreed upon with your seller, defined as: The vehicle mass with the standard equipment as per manufacturer's specifications incl. driver (75 kg), fuel tank filled up to 90 %, systems containing fluids filled up to 100 % (annexe V, clause 2.6, footnote (h) VO (EU) 1230/2012) as well as, if available, the trailer equipment, the mass of the spare wheel and of the tool.

Special equipment (additional equipment) and accessories increase the mass in running order and reduces the cargo load. Cargo load as per the catalogue specifications is defined as: Difference between the technically permissible total mass and the mass in running order. Refer to our prospectus or ask your dealer/seller for the weight of the special (additional) equipment and of the accessories.

The maximum permissible number of persons given is dependent on the weight and axle load. It can be reduced as a result of the installation of special equipment (additional equipment) and accessories, so that individual seats cannot be used in favour of load-carrying capacity. If all seats are supposed to be used, payload must be properly adjusted. The technically permissible total mass as well as the axle loads must not be exceeded.

The load-carrying capacity may be reduced as a result of the installation of special equipment (additional equipment) and accessories. The minimum cargo load must be adhered to at all times (refer to annexe I, clause 2.6.4.1.2 VO (EU) 1230/2012). The minimum cargo load is calculated as follows: Minimum cargo load in kg = (vehicle length in meters + maximum number of co-passengers + driver) x 10. Moreover, the load-carrying capacity is not only dependent on the mass in running order, the actual vehicle mass (article 2, clause 6 VO (EU) 1230/2012), the weight of the accessories and the technically permissible total mass, but also on the respective axle loads. In order to utilise the maximum load-carrying capacity of the vehicle requires axle-dependent load distribution. This must be verified before commencing every journey. Even all other regulations necessary for the safe operation of the vehicle must be adhered to when using the vehicle.

Mass and weight data is specified in accordance with VO (EU) 1230/2012 unless deviating regulations are made in the catalogues, price lists or the technical data.

